

CASTERS

1. LIGHT DUTY CASTERS
2. MEDIUM DUTY CASTERS
3. CUSHION CASTERS
4. GRIP RING TYPE CASTERS



CASTERS

SPECIFICATIONS

BOLT TYPE

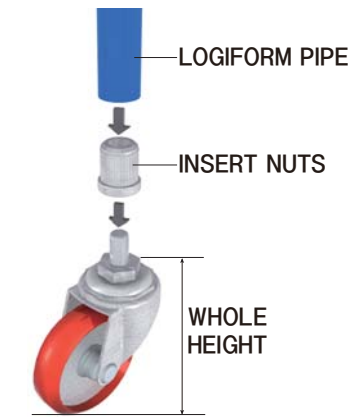
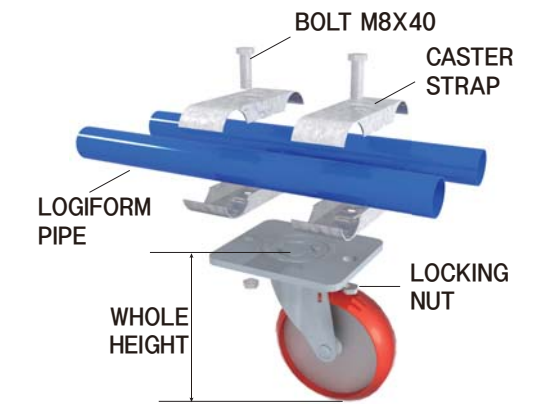
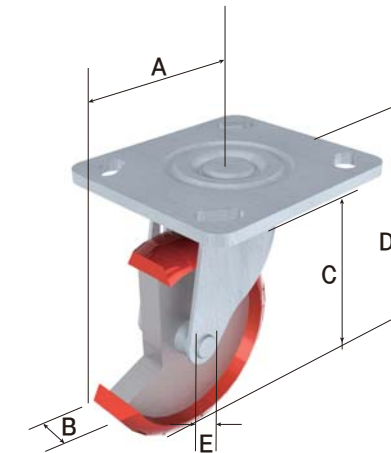

PLATE TYPE



DIMENSION



A	B	C	D	E
SWIVEL	WIDTH	DIAMETER	HEIGHT	Offset

DIVISION



하중에 따른 캐스터 선정 방법

$$S = (W+A)/(n-1) \quad (S: \text{안전 허용 하중(kgf)}, W: \text{운송 장비 중량(kg)}, A: \text{추가 적재 하중(kg)}, n: \text{부착된 캐스터 수량(pcs)})$$

- 본 계산식은 일반적인 평탄한 노면상태에서 사용하는것을 전제로 합니다.
- 캐스터에 충격을 줄 수 있는 요철과 문턱등 사용조건에서는 허용하중이 급격하게 감소하므로 사용을 제한해야 합니다.
- 안전 허용 하중에 적합하지 않은 캐스터를 사용하면 제품 결함 및 신체상 상해의 원인이 될 수 있습니다.

$$S = (W+A)/(n-1) \quad (S: \text{Safe load(kgf)}, W: \text{Weight of mobile structure(kg)}, A: \text{Weight of load(kg)}, n: \text{Number of caster(pcs)})$$

- This calculation is subject to use on flat floor.
- Be aware that bumpy road can affect load capacity.
- You must follow recommended load capacity.

LIGHT DUTY CASTERS (BOLT TYPE)

IMAGE	PRODUCT CODE	OPTION	⊗ inch (mm)	⊕ inch (mm)	⊖ mm	⊗ mm	⊕ kg (max)	WHEEL	BEARING	PRODUCT WEIGHT kg	Q' TY/BOX	
	CT-702S	SWIVEL	2"	1/2	20	44	72	35	PLY	Plain	0.16	160
	CT-702B	SWIVEL-BRK									0.16	
	CT-703S	SWIVEL	3"	5/8	32	73	108	100	PLY	Ball	0.69	32
	CT-704S		4"	5/8	32	89	133	105	PLY	Ball	0.79	24
	CT-703B	SWIVEL-BRK	3"	5/8	32	73	108	100	PLY	Ball	0.75	32
	CT-704B		4"	5/8	32	89	133	105	PLY	Ball	0.89	24

■ WHEEL = PLY : Polyurethane Tread / Plastic Center Wheels
 ■ BEARING = PLAIN / BALL : Wheel bearing type

LIGHT DUTY CASTERS (PLATE TYPE)

IMAGE	PRODUCT CODE	OPTION	⊗ inch (mm)	⊕ inch (mm)	⊖ mm	⊗ mm	⊕ kg (max)	WHEEL	BEARING	PRODUCT WEIGHT kg	Q' TY/BOX		
	CT-713RL	RIGID	3"	32	X	104	100	PLY	Ball	0.54	32		
	CT-714RL		4"	32						129	105	0.83	24
	CT-715RL		5"	32						156	115	0.74	20
	CT-713SL	SWIVEL	3"	32	X	104	100	PLY	Ball	0.83	32		
	CT-714SL		4"	32						129	105	0.94	24
	CT-715SL		5"	32						156	115	1.03	20
	CT-713BL	SWIVEL-BRK	3"	32	X	104	100	PLY	Ball	0.88	32		
	CT-714BL		4"	32						129	105	1.03	24
	CT-715BL		5"	32						156	115	1.12	20

■ WHEEL = PLY : Polyurethane Tread / Plastic Center Wheels
 ■ BEARING = BALL : Wheel bearing type

*Please contact our sales office with reference to the additional options available.

LIGHT DUTY CASTERS (ESD TYPE) ⚡

IMAGE	PRODUCT CODE	OPTION	⊗ inch (mm)	⊕ inch (mm)	⊖ mm	⊗ mm	⊕ kg (max)	WHEEL	BEARING	PRODUCT WEIGHT kg	Q' TY/BOX		
	CT-713RE	RIGID	3"	32	X	104	56	SR(ESD)	Ball	0.58	32		
	CT-714RE		4"	32						129	75	0.88	24
	CT-715RE		5"	32						156	80	1.17	20
	CT-713SE	SWIVEL	3"	32	X	104	56	SR(ESD)	Ball	0.87	32		
	CT-714SE		4"	32						129	75	1.05	24
	CT-715SE		5"	32						156	80	1.24	20
	CT-713BE	SWIVEL-BRK	3"	32	X	104	56	SR(ESD)	Ball	0.93	32		
	CT-714BE		4"	32						129	75	1.32	24
	CT-715BE		5"	32						156	80	1.72	20

■ WHEEL = SR : Soft Rubber Wheels
 ■ BEARING = BALL : Wheel bearing type











MEDIUM DUTY CASTERS-LOW (PLATE TYPE)

IMAGE	PRODUCT CODE	OPTION	⊗ inch (mm)	⊕ inch (mm)	⊖ mm	⊗ mm	⊕ kg (max)	WHEEL	BEARING	PRODUCT WEIGHT kg	Q' TY/BOX		
	CT-714RH	RIGID	4"	38	X	137	200	PU	ROLLER #001	1.72	10		
	CT-715RH		5"	40						165	250	2.15	10
	CT-716RH		6"	44						190	270	2.63	8
	CT-714SH	SWIVEL	4"	38	X	137	200	PU	ROLLER #001	1.85	10		
	CT-715SH		5"	40						165	250	2.58	10
	CT-716SH		6"	44						190	270	2.94	8
	CT-714BH	SWIVEL-BRK	4"	38	X	137	200	PU	ROLLER #001	1.85	10		
	CT-715BH		5"	40						165	250	2.77	10
	CT-716BH		6"	44						190	270	3.14	8

■ WHEEL = PU : Polyurethane









*Please contact our sales office with reference to the additional options available.

MEDIUM DUTY CASTERS-HIGH (PLATE TYPE)

IMAGE	PRODUCT CODE	OPTION	 inch (mm)	 inch (mm)	 mm	 mm	 kg (max)	 mm	 mm	WHEEL	BEARING	PRODUCT WEIGHT kg	Q' TY/BOX
	CT-714RW	RIGID	4"	48		141	320	114 x 102	92~76 x 76 ~66	PU	Ball	1.89	10
	CT-715RW		5"	48	X	165	340			PU	Ball	2.09	10
	CT-716RW		6"	48		190	360			PU	Ball	2.58	8
	CT-714SW	SWIVEL	4"	48	76	141	320	114 x 102	92~76 x 76 ~66	PU	Ball	2.27	10
	CT-715SW		5"	48	90	165	340			PU	Ball	2.51	10
	CT-716SW		6"	48	108	190	360			PU	Ball	3.1	8
	CT-714BW	SWIVEL-BRK	4"	48	76	141	320	114 x 102	92~76 x 76 ~66	PU	Ball	2.42	8
	CT-715BW		5"	48	90	165	340			PU	Ball	2.66	8
	CT-716BW		6"	48	108	190	360			PU	Ball	3.21	6











■ WHEEL = PU : Polyurethane

CUSHION CASTERS (PLATE TYPE)

IMAGE	PRODUCT CODE	OPTION	 inch (mm)	 inch (mm)	 mm	 mm	 kg (max)	 mm	 mm	WHEEL	BEARING	PRODUCT WEIGHT kg	Q' TY/BOX
	CT-726RC (PC)	RIGID										5.146	
		SWIVEL	6"	48	128	203	360kg	160*115	129*72.5	Poly Urethane	Ball	5.876	4ea/box
	CT-726BC (PC)	SWIVEL-BRK										6.178	







*Please contact our sales office with reference to the additional options available.

HIGH POLYURETHANE CASTERS (PLATE TYPE)

IMAGE	PRODUCT CODE	OPTION	 inch (mm)	 inch (mm)	 mm	 mm	 kg (max)	 mm	 mm	WHEEL	BEARING	PRODUCT WEIGHT kg	Q' TY/BOX
	CT-713RP	RIGID	3"	32		104	56	95 x 64	76 to 73 x 45	HPU H.P.U / Plastic	Ball	0.45	32
	CT-714RP		4"	32	X	129	75				Ball	0.55	24
	CT-715RP		5"	32		156	80				Ball	0.66	20
	CT-713SP	SWIVEL	3"	32	78	104	56	95 x 64	76 to 73 x 45	HPU H.P.U / Plastic	Ball	0.74	32
	CT-714SP		4"	32	89	129	75				Ball	0.84	24
	CT-715SP		5"	32	101	156	80				Ball	0.97	20
	CT-713BP	SWIVEL-BRK	3"	32	78	104	56	95 x 64	76 to 73 x 45	HPU H.P.U / Plastic	Ball	0.80	32
	CT-714BP		4"	32	89	129	75				Ball	0.93	24
	CT-715BP		5"	32	101	156	80				Ball	1.06	20







■ WHEEL = HPU : High Polyurethane

HIGH POLYURETHANE CASTERS (BOLT TYPE)

IMAGE	PRODUCT CODE	OPTION	 inch (mm)	SIZE "A" inch	 inch (mm)	 mm	 mm	 kg (max)	WHEEL	BEARING	PRODUCT WEIGHT kg	Q' TY/BOX
	CT-703SP	SWIVEL	3"	5/8	32	78	104	56	HPU H.P.U / Plastic	Ball	0.62	32
	CT-704SP		4"	5/8	32	89	129	75		Ball	0.75	24
	CT-705SP		5"	5/8	32	101	156	80		Ball	0.88	20
	CT-703BP	SWIVEL-BRK	3"	5/8	32	78	104	56	HPU H.P.U / Plastic	Ball	0.68	32
	CT-704BP		4"	5/8	32	89	129	75		Ball	0.84	24
	CT-705BP		5"	5/8	32	101	156	80		Ball	0.96	20









■ WHEEL = HPU : High Polyurethane

BALL CASTER

IMAGE	PRODUCT CODE	OPTION	 inch (mm)	SIZE "A" inch	 inch (mm)	 mm	 mm	 kg (max)	WHEEL	BEARING	PRODUCT WEIGHT kg	Q' TY/BOX
	BC-701S	SWIVEL	1"					20				

*Please contact our sales office with reference to the additional options available.

NEW GRIP RING TYPE CASTERS

IMAGE	PRODUCT CODE	OPTION	 inch (mm)	 inch (mm)	 mm	 mm	 kg (max)	threaded specification	WHEEL	BEARING	PRODUCT WEIGHT kg	Q' TY/BOX
	CT-703RR	RIGID	3"	32	x	100	75	Ø11x38mm	PU	Plain	0.44	40
	CT-703SR	SWIVEL	3"	32	70	100	75	Ø11x38mm	PU	Plain	0.5	40
	CT-703BR	SWIVEL-BRK	3"	32	70	100	75	Ø11x38mm	PU	Plain	0.56	40

■ WHEEL = PU : Polyurethane

NEW INSERT FOR GRIP RING TYPE CASTER

CI-1109SP

SUS PIPE Ø 26 × T0.9



CASTER INSERT



26
45
29
■ 22.6g/ea

CI-1111SP

SUS PIPE Ø 25.6 × T1.1



CASTER INSERT

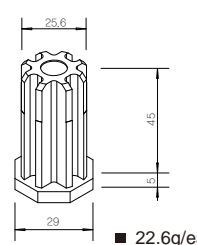

25.6
45
29
■ 22.6g/ea

CI-1110LP

COATING PIPE Ø 23.7 × T1



CASTER INSERT



23.7
45
29
■ 22.6g/ea

